



Raufoss ProRack

– for Defence and Police

Raufoss ProRack

Raufoss ProRack is a modular rack system designed for professional users, including defense forces and police. It sets a new standard for high security and rapid access.

Optimized for the local storage of weapons in frequent (daily) use, the system can be installed in strongrooms, armories, and large gun safes.

Developed in collaboration with the Norwegian Defence Logistics Organisation, Raufoss ProRack is now being deployed at military bases nationwide. It is designed to accommodate all types of personal soldier weapons, from pistols and assault rifles to heavy machine guns.

Its modular design provides exceptional flexibility, allowing for easy customization to meet specific requirements. Users can adapt the system at any time to accommodate new applications or weapon types.

Each Raufoss ProRack unit is equipped with either an integrated coded padlock for individual weapons or a locking system for multiple weapons.

Key Features:

- High security
- Rapid access in emergencies
- Space-efficient design
- Flexible and adaptable
- Clear, instant overview of weapon status

Index

Raufoss ProRack.....	2	Storage of heavy machine guns.....	16
ProRack One.....	4	Panel Cabinet.....	20
ProRack eBox.....	5	Armoury Safe.....	21
ProRack pBox.....	6	Drawers.....	23
ProRack Panel system.....	7	Shelves.....	24
Panel wall.....	8	Safety cabinets.....	26
Trolley.....	9	Unloading stations.....	29
Multi modules.....	10	Accessories.....	30
Armoury program.....	12		



ProRack One

PART NUMBER: ProRack One: 803014
 ProRack One L: 803015
 ProRack One XL: 803016

- Telescopic weapon stand
- Can be used for all common assault rifles and machine pistols
- Easy length adjustment
- Intergrated code padlock



Weapon type	Weapon stand length [cm]
G3, AG3	108,0
HK417	105,0
FN MINIMI	91,7
HK416	87,8
HK416K	72,6
G3, AG3 retractable stock	87,0
MP5	75,1
MP5 retractable stock	57,4
MP7	57,2

* Use ProRack L for weapons longer than 90 cm
 Use ProRack XL for weapons longer than 110 cm

ProRack eBox

PART NUMBER: 804023

- Equipment box for weapon accessories
- Integrated cassette for handguns (optional)
- Large window for easy inspection
- Integrated code padlock
- Tilt box for easy access
- Tilt box can be lifted out



Other eBox interior can be provided on request

External dimensions [cm]		Internal dimensions [cm]	
Height	43,5	Height	40
Width	19,5	Width	18
Depth	29,5	Depth	26,5



ProRack pBox

PART NUMBER: 803030

- Storage box for pistols
- Large window for easy inspection
- Integrated code padlock
- Easy access

External dimensions [cm]	
Height	27
Width	19
Depth	6



ProRack Panel system

PART NUMBER: See table

The panel building system makes it easy to install Raufoss ProRack. Start with mounting the panels on the wall, using panels of different sizes to «build around» light switches, fire extinguishers and other obstacles. Thereafter attach the ProRack equipment (weapon stands, boxes, shelves etc) to the panels at the desired positions. The equipment can later be repositioned to suit new user needs.

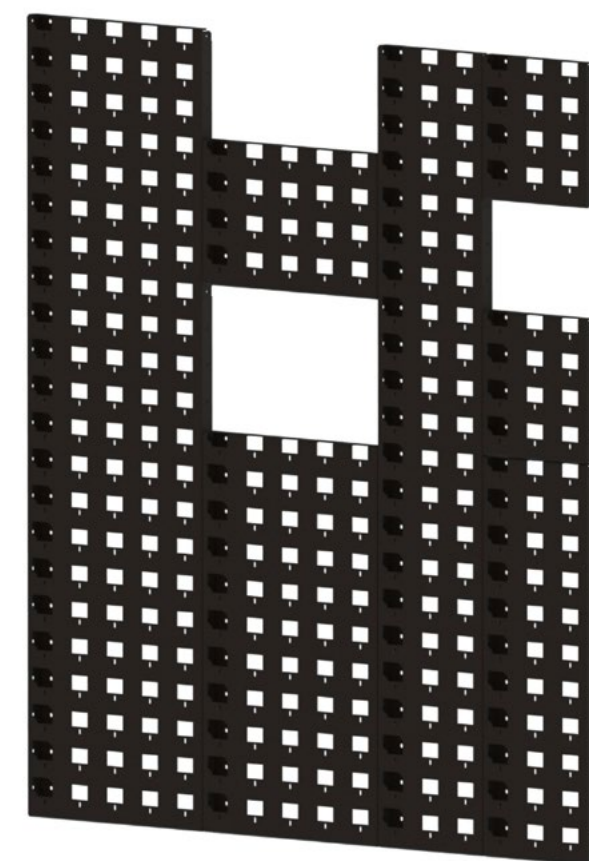
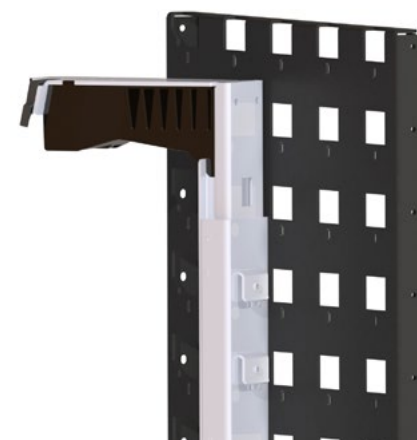

Panels and dimensions [cm]	Part number
Rack Panel H165 W60	800011
Rack Panel H165 W50	801011
Rack Panel H165 W30	802011
Rack Panel H82 W60	800034
Rack Panel H82 W50	801021
Rack Panel H82 W30	802021
Rack Panel H50 W50	800032
Rack Panel H50 W30	800033
Rack Panel H30 W50	801031
Rack Panel H30 W30	802031

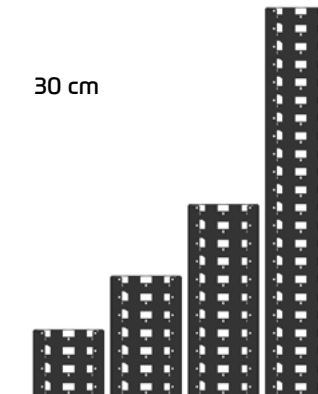
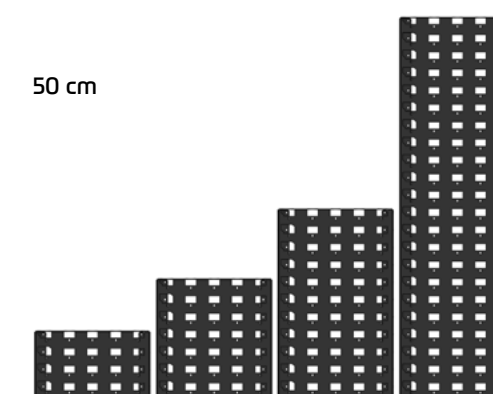
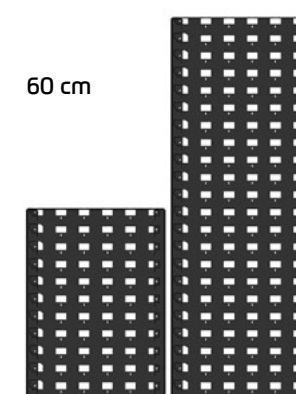

Panel wall

PART NUMBER: See table

- Free-standing wall
- For maximum utilization of floor area
- Panels on both sides
- Base length 1.0 m and 1.2 m
- Wall extension with 0.3 m and 0.5 m sections

Panels and dimensions [cm]	Part number
Free-standing panel wall L = 100 cm	808010
Free-standing panel wall L= 120 cm	808012
Side panel for extension of wall	808011



Trolley

PART NUMBER: See table

- Can be equipped with all ProRack product combinations
- Trolley can be custom-built on request



Trolley with 12-in-1 Module
See page 11 for more information

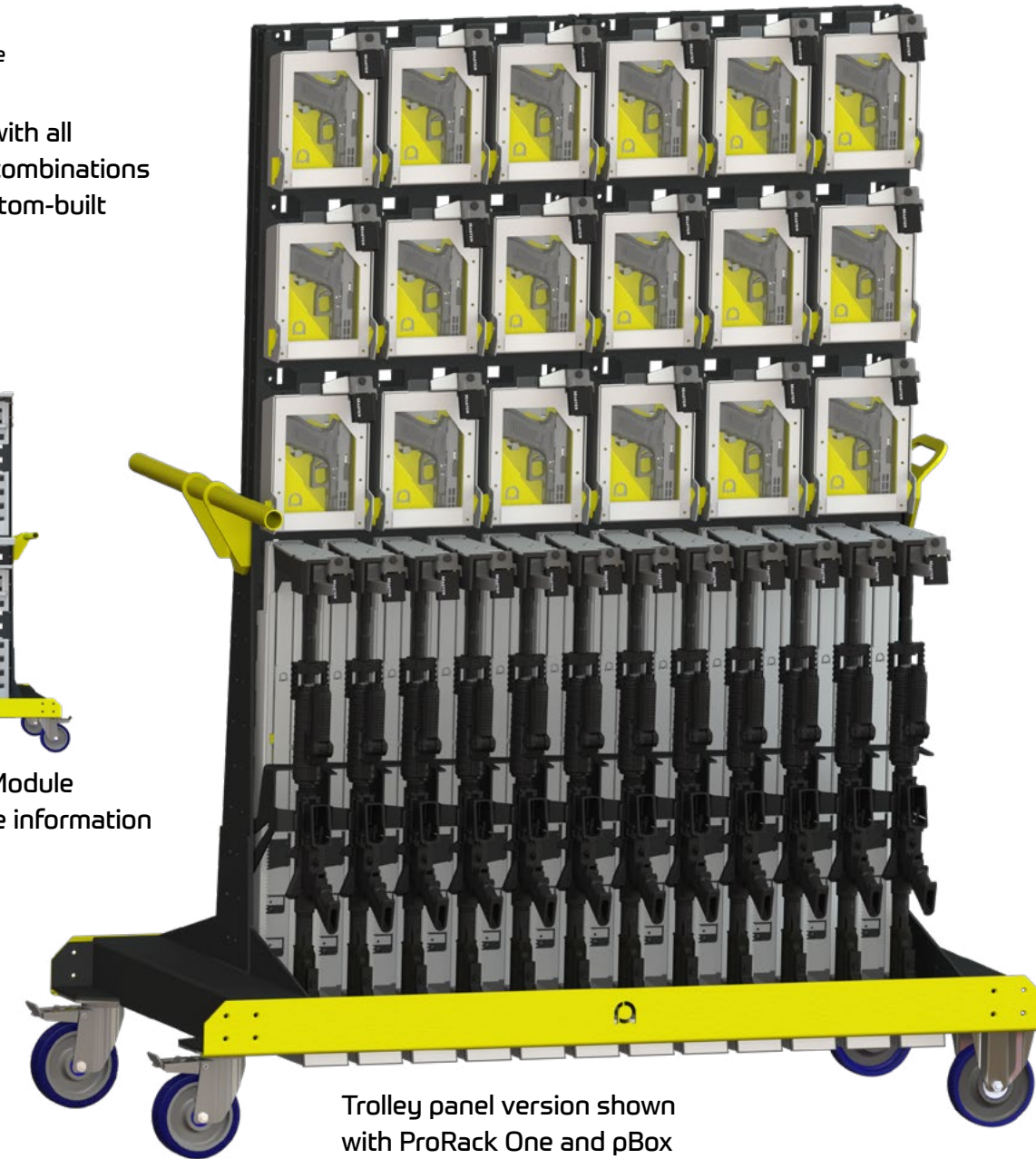

Trolley panel version shown with ProRack One and pBox

Version	Dimensions (cm)	Part number
Trolley frame version	H:1925 L:1552 W:770	808040
Trolley panel version	H:1925 L:1552 W:770	808030

Trolley with panels



Multi modules

Space efficient storage units for multiple weapons

10-in-1 Module

PART NUMBER: 803050

- For 10 weapons
- Easy length adjustment
- The overlapping feature maximizes the number of weapons in height
- Lock all 10 weapons with padlock (sold separately, page 27)
- Other weapon capacities are available on request
- Delivered with black powder coat

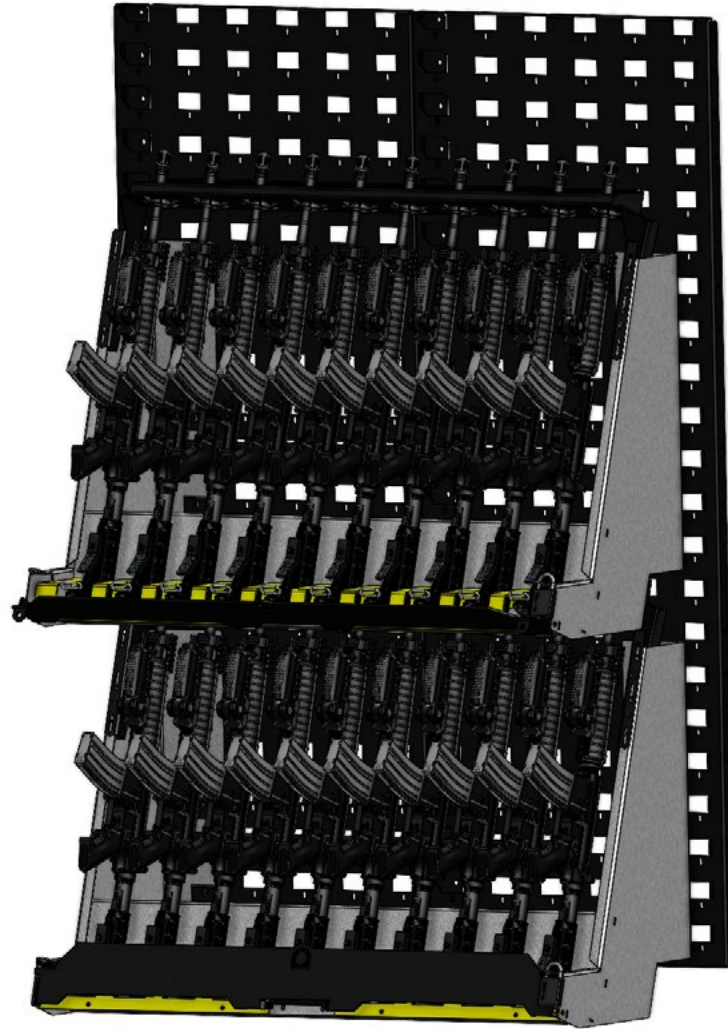

10-in-1 Overlap Module mounted on ProRack panels in two heights

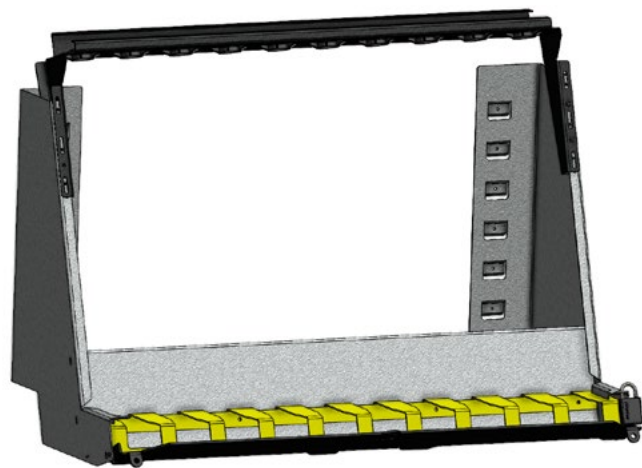

12-in-1 Module

PART NUMBER: 803070

- For use on wall and trolley
- The distance between the upper and lower unit can be adjusted to fit different weapons
- All 12 weapons can be locked with a WireLock

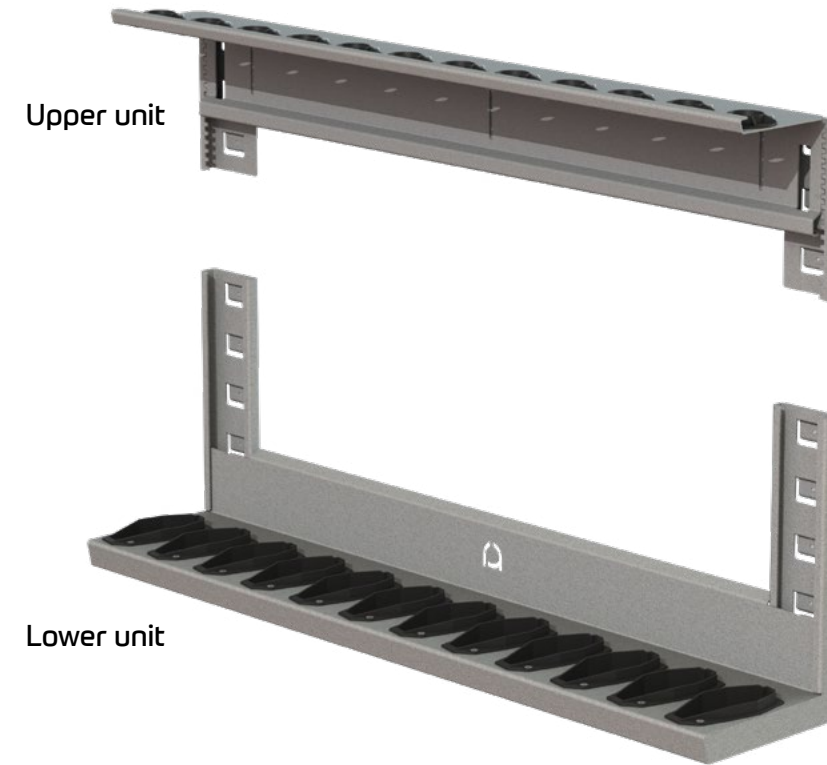

12-in-1 Module with weapons

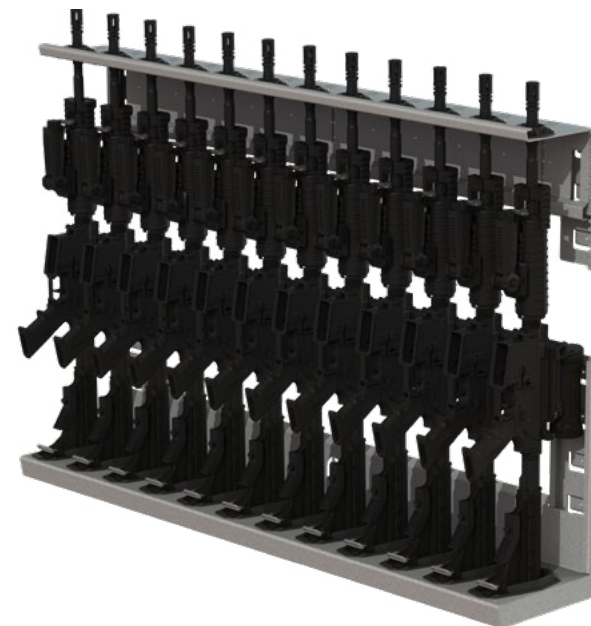

12-in1 Modules mounted on Trolley



Armoury program

The Armoury product line consists of a wide range of storage units that can be used where individual locking of each weapon is not needed.

Combine High and Low units from a wide product range to build optimized storage solutions.

The pictures below show examples of how the units can be combined for storage of different weapons.

Wire and padlock's are sold separately, find more information on page 30.



Combination of High 5 and Low 5

Combination of High 1 and Low 1



Low 1
PART NUMBER: 920647
Depth 370 mm



MG Low 231
PART NUMBER: 830057
Depth 231 mm



MG Low 310
PART NUMBER: 920215
Depth 310 mm

MG Low wide
PART NUMBER: 809055
Depth 370 mm
(also available in 345 mm for Trolley)



Low 5
PART NUMBER: 809065

High 1
PART NUMBER: 809045



High wide
PART NUMBER: 809035



Hole 1
PART NUMBER: 809088



Hole 5
PART NUMBER: 920830

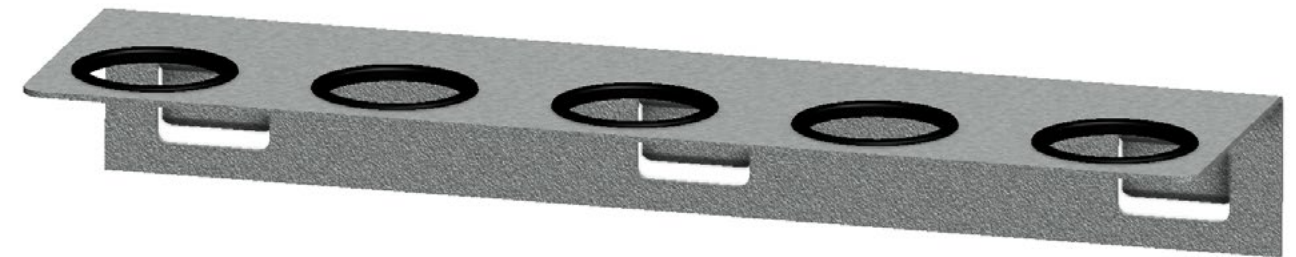

High 5
PART NUMBER: 809026

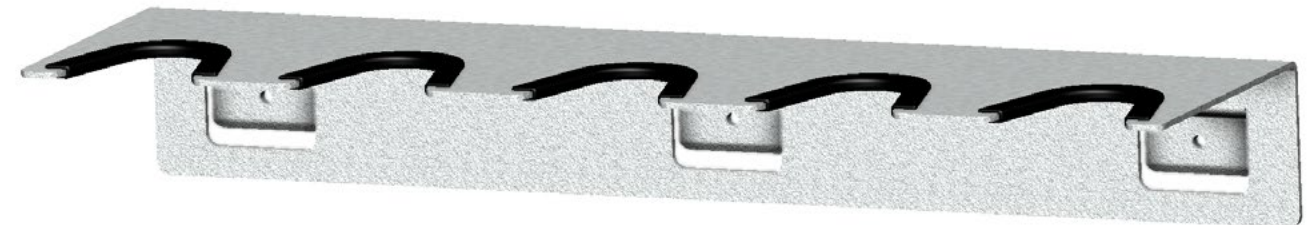

HMG 50 cal upper
with lock
PART NUMBER: 809015



MG Upper FN MAG / M240
with extra barrel
PART NUMBER: 830053

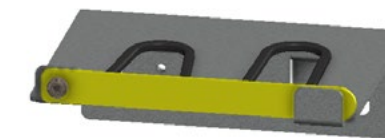

MG Barrel support upper FN MAG / M240
with lock
PART NUMBER: 830041

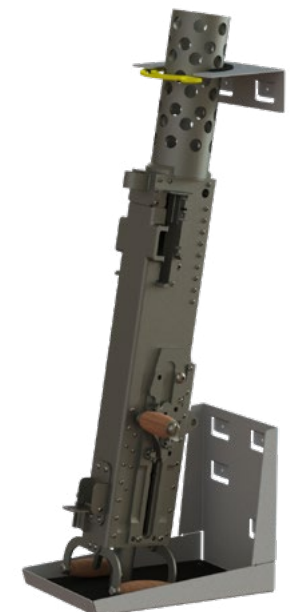

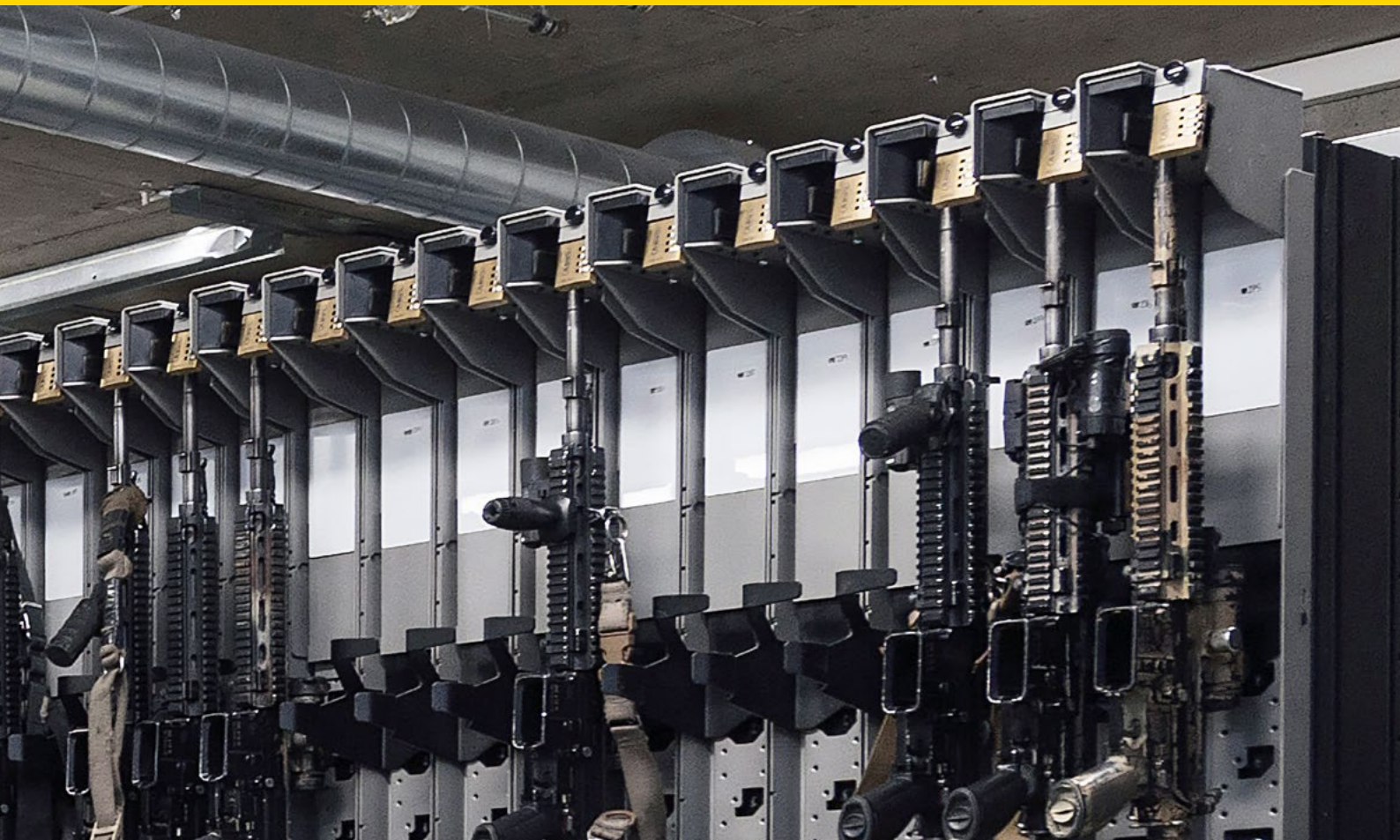

HandGun 1

PART NUMBER: 809089



HandGun 2

PART NUMBER: 809091



HandGun 6

PART NUMBER: 809092



TASER X2 HOLDER

PART NUMBER: 920949

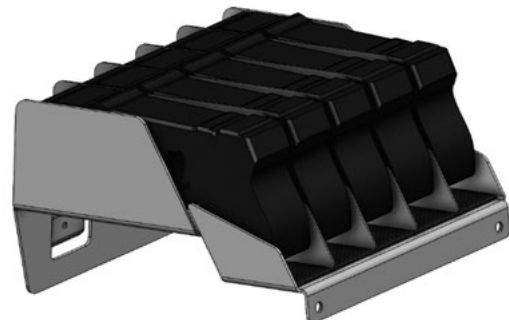

Horizontal RCL

PART NUMBER: 803044
 Support for recoilless rifle, Carl Gustav or similar.
 Radius= 70 mm
 Sold in pairs



Horizontal 4

PART NUMBER: 803048
 Sold in pairs

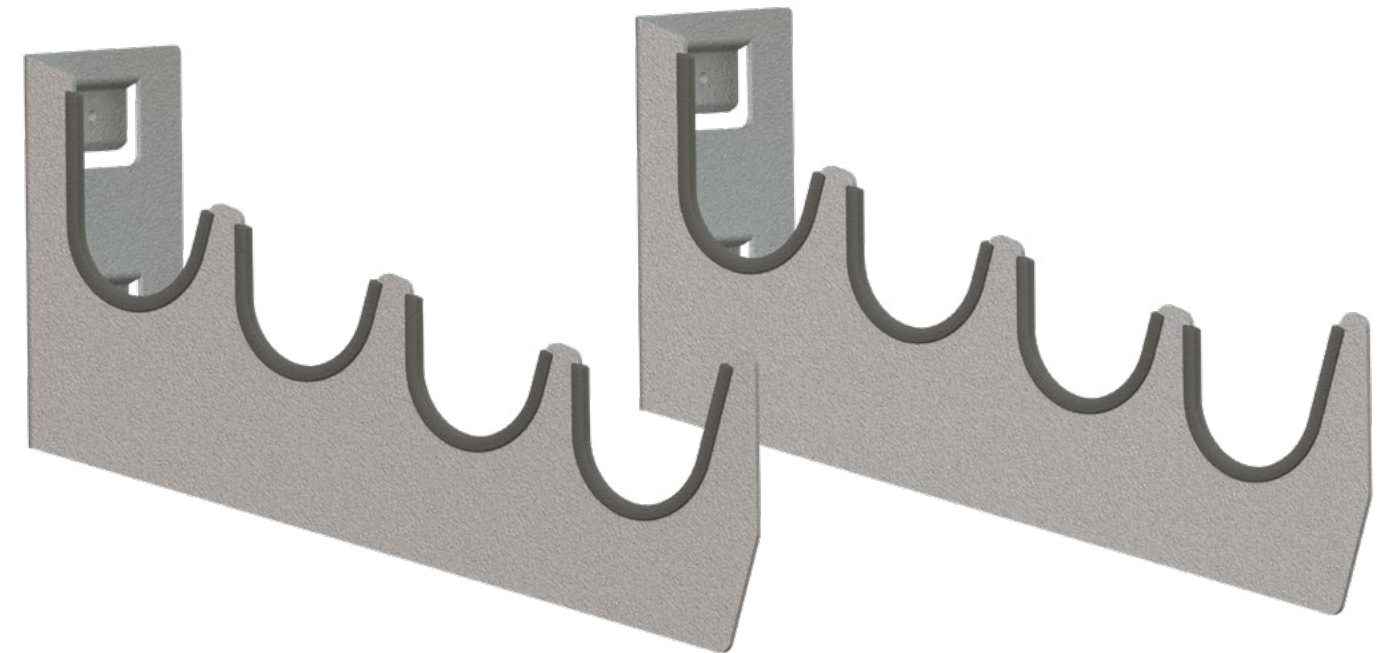

Horizontal 4 with machine guns

Storage of heavy machine guns

- Many of the products in the armoury program are designed for support weapons and heavy machine guns
- All Armoury program units are designed for easy mounting on ProRack panels, and are well suited for mounting in safety cabinets
- Please contact us for advice on storage solutions

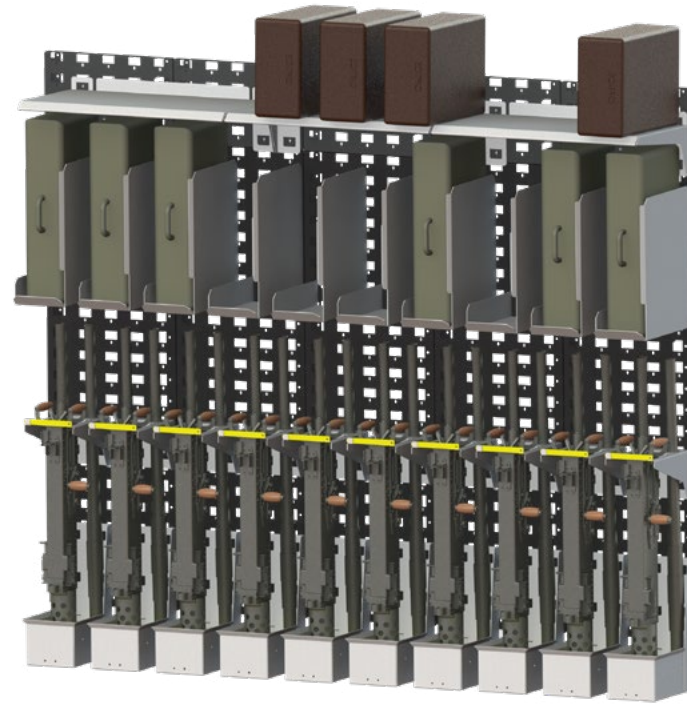

Picture show wall with Shelf 60 in use. For more information see page 24.



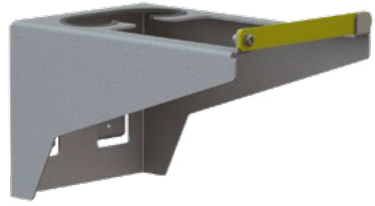

HMG Module M2 CQB

PART NUMBER: 803041

For heavy machine guns.
The module consists of an upper and lower part, and is height adjustable.



Can be delivered for multiple weapons upon request



RCL Upper Carl Gustaf

PART NUMBER: 920699

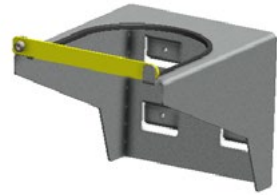

RCL Lower Carl Gustaf

PART NUMBER: 920700



MG MK19

PART NUMBER: 830056



MG MK19

PART NUMBER: 830055



Panel Cabinet

- Individual locker, to be mounted on ProRack Panels
- ProRack storage units can be placed inside Panel Cabinet
- Locking with pad lock
- Can be ordered with shelf

Panel Cabinet

PART NUMBER: 920450
 Width: 40 cm
 Height: 165 cm
 Depth: 35,5 cm

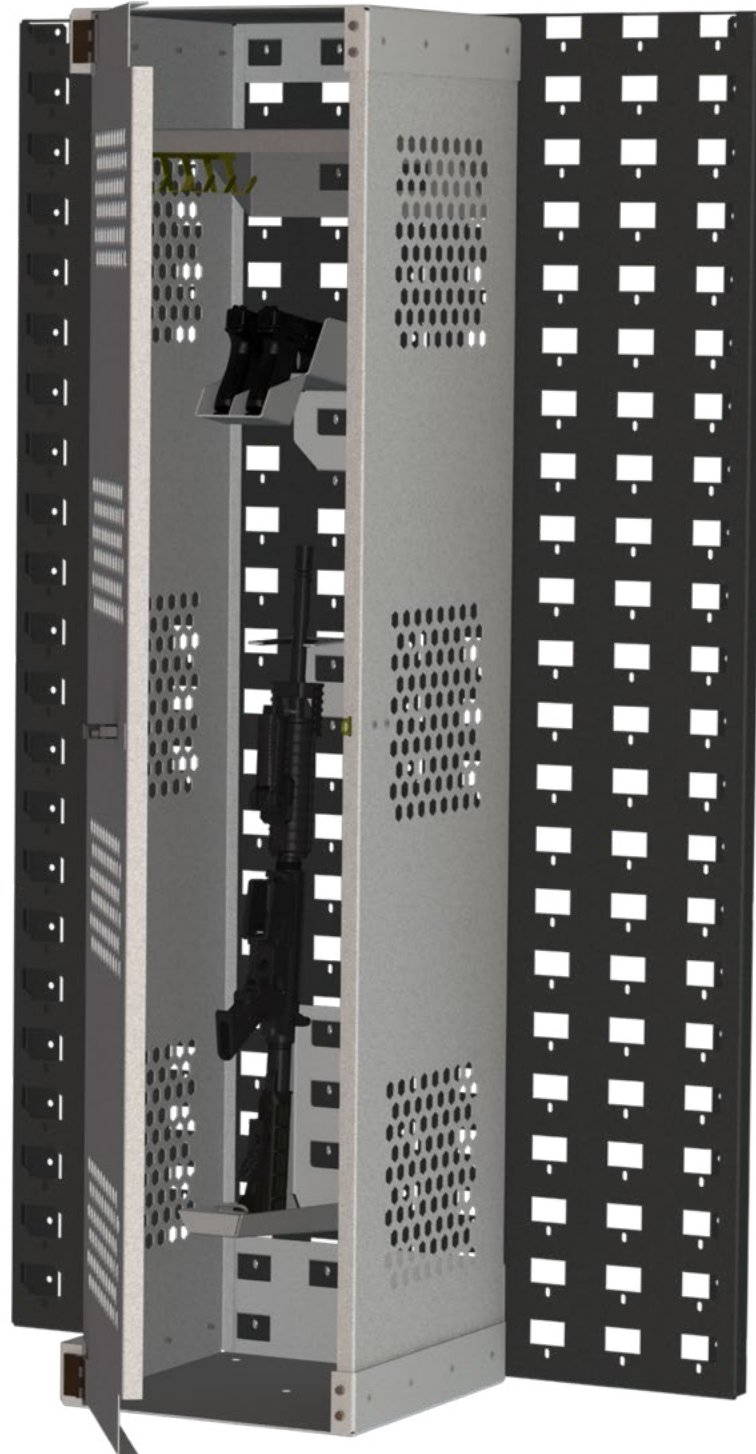

Armoury Safe

- Armoury safes manufactured in 2,5mm steel plate.
- Delivered with security lock according to En1300 - A.
- 3 point lock approved by UK Armed Police.
- Approved and used by UK Armed Police.
- Bolts for securing to floor/wall are included.

Armoury Safe AS 15114 Team Cabinet

PART NUMBER: 920765
 H:148 cm W:107 cm D:40 cm

Designed for 10 weapons
 Is equipped with ProRack panel system

ProRack storage units can be placed inside Panel Cabinet



Armoury Safe AS 856 Opsbox

PART NUMBER: 920748
 H:80 cm
 W:50 cm
 D:58 cm

Will fit 1 assault rifle and a body armour with full kit.

Opsboxes are stackable





Drawers

- Drawers can be mounted on ProRack panels
- Allows easy storage of equipment and documents
- Drawers can be delivered with foam inlay or dividers for weapons and other equipment.
- Drawer 30 SSK and Drawer 60 SSK can be mounted in SSK Armoury safes

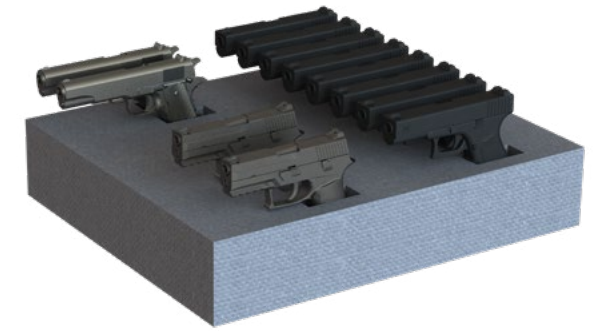

Double foam inlay

PART NUMBER: 920367
For Drawer 60



Safety cabinets with Armoury program units installed

Drawer 30

PART NUMBER: 807022
Width: 28,5 cm
Height: 26 cm
Depth: 50 cm

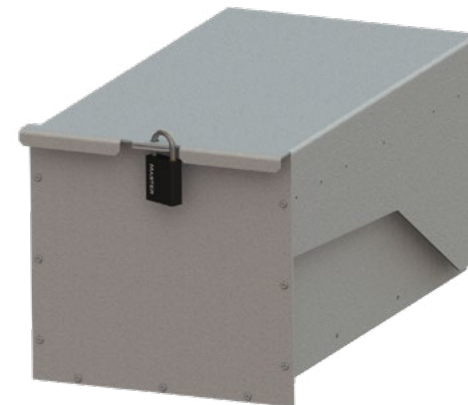

Drawer 60

PART NUMBER: 807021
Width: 58 cm
Height: 33,5 cm
Depth: 50 cm



Drawer 30 SSK

PART NUMBER: 920716
Width: 28,5 cm
Height: 26 cm
Depth: 36 cm

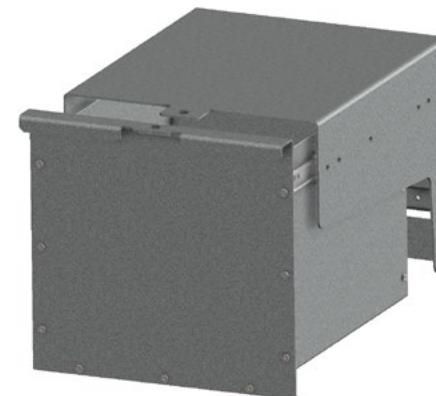

Drawer 60 SSK

PART NUMBER: 920712
Width: 58 cm
Height: 33,5 cm
Depth: 36 cm

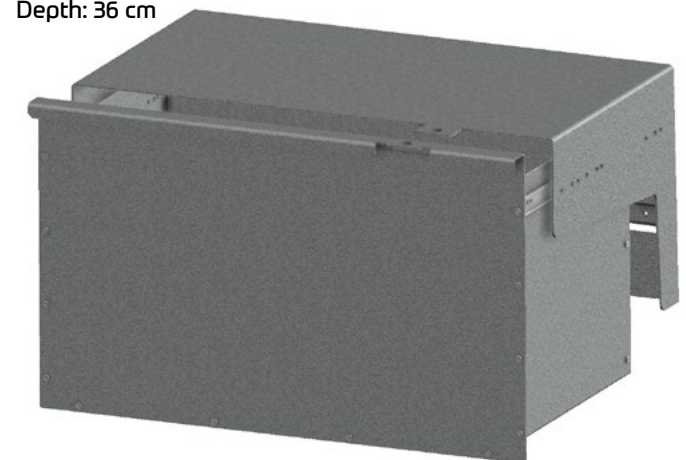

Shelves

- Shelves can be mounted on ProRack panels
- Strong shelves with self supporting construction and no legs
- Allows easy storage of equipment and documents
- Shelf SSK 190 can be mounted in SSK 190 Armoury safe
- Shelf SSK 290 can be mounted in SSK 290 Armoury Safe

Shelf Panel Cabinet

PART NUMBER: 920447 W: 40 cm



Shelf with hooks

PART NUMBER: 920543
W: 40 cm H: 10 cm D: 35,5 cm



Shelf SSK 190

PART NUMBER: 920713
W: 60 D: 36 cm

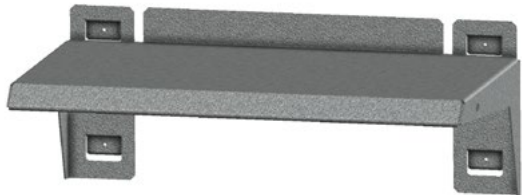

Shelf SSK 290

PART NUMBER: 920695
W: 90 cm D: 36 cm

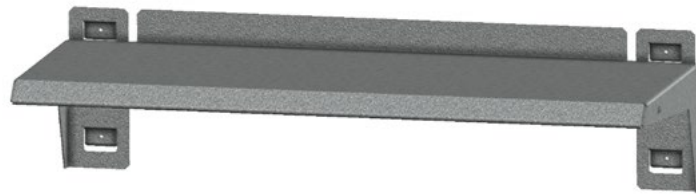

Shelf 60

PART NUMBER: 807012
W: 100 D: 60 cm

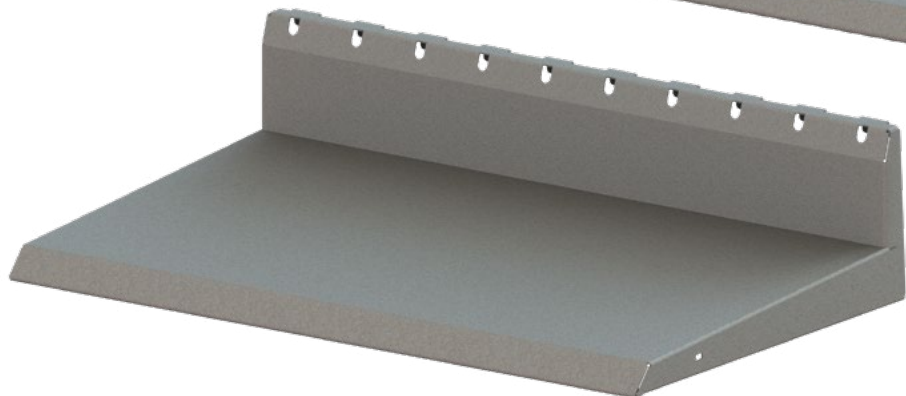

Shelf 40

PART NUMBER: 807013
W: 100 cm D: 40 cm

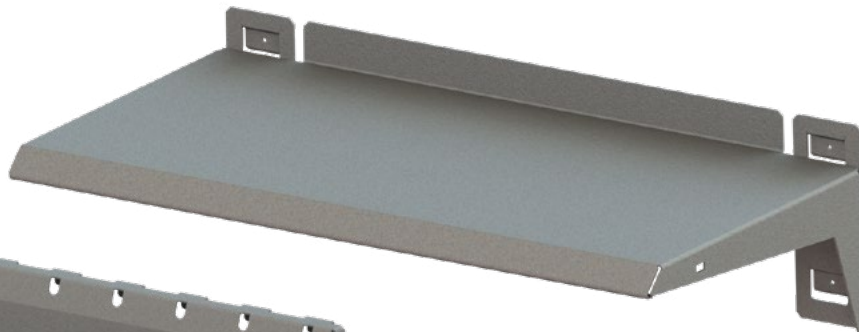

Shelf bracket

PART NUMBER: 811013
W: 19 cm
D: 34 cm



Box with window

PART NUMBER: 920466
W: 210 mm
D: 192 mm
H: 78 mm



Shelf 20 Bag

PART NUMBER: 920003
W: 19,5 cm
D: 40 cm
H: 50 cm

Picture shows Shelf
60 units installed

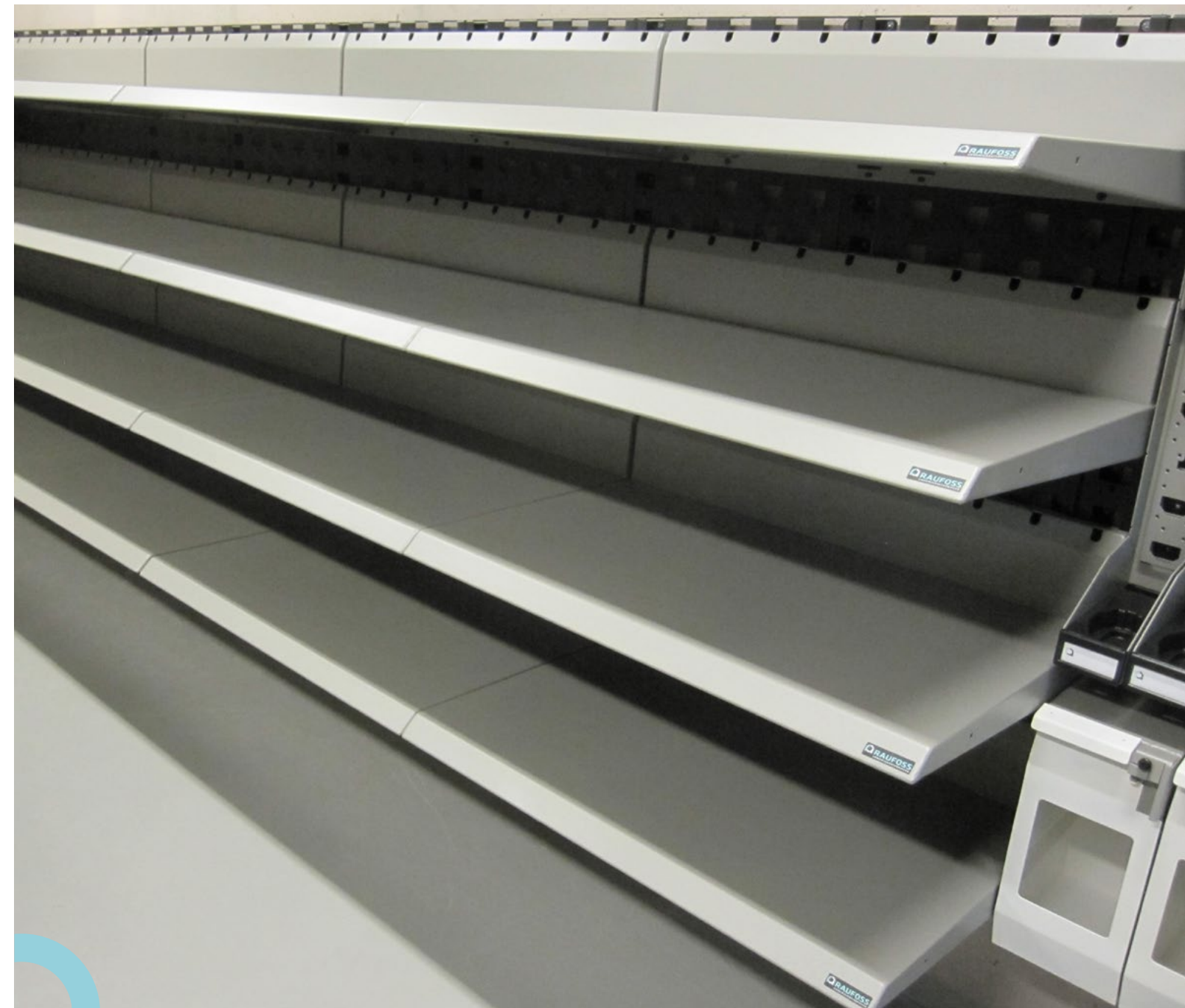

Safety cabinets

PART NUMBER: See table

Safety cabinets are used for safe storage of weapons, ammunition and other valuables. The cabinets are prepared for installation of alarm sensors and are approved as burglary protection. They can be equipped with ProRack weapon storage units or with shelves for ammunition and document storage.

Safety cabinet	Dimensions [cm]	Weight (kg)	Part number w/el. code lock
SSK 290	H190 x W100 x D48	300	810040
SSK 190	H190 x W75 x D48	225	810030
SSK 150	H150 x W55 x D48	160	810020
SSK 70	H73 x W55 x D48	90	810070
SSK 190 ammunition safe	H190 x W100 x D48	225	820010
SSK 150 ammunition safe	H150 x W55 x D48	160	820020

The safety cabinets are supplied with an electronic code lock.



Ammunition and weapon safe with electronic code lock SSK 150

PART NUMBER: 810020 (Weapon safe), 820020 (Ammunition safe)

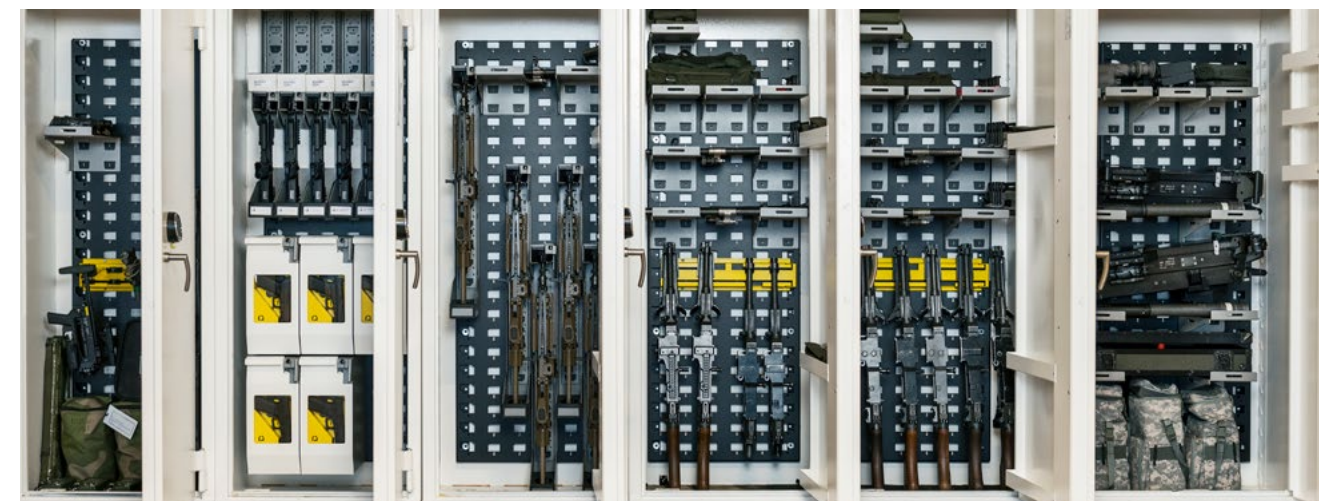

Ammunition and weapon safe with electronic code lock SSK 190

PART NUMBER: 810030

Safety cabinet for weapon storage. The cabinet accommodates up to 12 ProRack One weapon stands, 12 eBoxes, or a combination of the two, for example 6 of each. The cabinet is prepared for magnetic contacts and seismic sensor.

SSK 190 can be equipped with ProRack weapon storage units or shelves for ammunition and document storage.





Ammunition and weapon safe with electronic code lock SSK 290

PART NUMBER: 810040

The SSK 290 safety cabinet can accommodate up to 18 ProRack One, 16 eBoxes or a combination of the two.

The cabinet is prepared for magnetic contacts and a seismic sensor.

ProRack storage units are ordered separately.

SSK 70

PART NUMBER: 810070



Unloading stations

PART NUMBER: See table

Unloading station made with ballistic material inserts. Robust construction traps the bullet securely. Certified up to 12.7 mm armour piercing bullets.



The unloading station can be delivered as desktop, wall-mount or ground standing pedestal version.

Model	Part number
Desktop	830010
Wall-mount	830020
Pedestal	830030
All weather cover	920876



Accessories

MasterLock Padlock with code

PART NUMBER: 806015

Padlock for ProRack One, pBox, bBox and eBox.



Electronic codelock (SSK series)

PART NUMBER: 359030

For instructions, see: www.raufoss.com/download



Pad lock clamp with grip knob

PART NUMBER: 207025

Used for ProRack One, pBox, bBox and eBox. Positions the padlock.



WireLock

PART NUMBER: 809085

For locking weapons and other equipment with safety-wire. Designed to be mounted on ProRack panel.

Pad lock and wire to be ordered separately.

Wire available in multiple lengths.

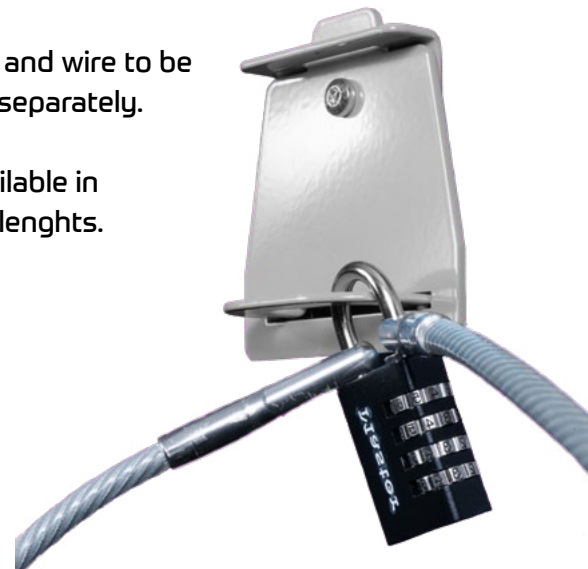

Notes





To order or for more information please contact
Raufoss Engineering AS

Telephone

+47 468 99 000

E-mail

post@raufoss.com

www.raufoss.com

